

Video • Data • Power

HubSatTM

NEW!

***Passive UTP Transceiver Hub
with Integral Camera Power***

Installation Guide

Models Include:

HubSat8

- Eight (8) Camera Channels

HubSat82

- HubSat8 w/eight (8) HubWayAv Video Balun/Combiners for 24VAC Cameras

HubSat83

- HubSat8 w/eight (8) HubWayDv Video Balun/Combiners for 12VDC Cameras



Overview:

Altronix HubSat8 Passive UTP Transceiver Hub w/Integral Camera Power transmits UTP video, RS422/RS485 data and power over a single CAT-5 or higher structured cable. Unit provides 8 camera channels in a wall mount enclosure. Video transmission range is up to 750 ft. max. per channel. Units are compatible with AC and/or DC fixed or PTZ cameras when utilizing Altronix HubWayAv or HubWayDv Video Balun/Combiners. In addition, the unit features individually selectable 24VAC or 28VAC fuse or PTC protected outputs with surge suppression. Optionally, the HubSat8 can be used as an accessory module to transmit video from up to 8 cameras over a single CAT-5 or higher structured cable back to the HubWay, HubWayLD or HubWayLDH Passive and Active UTP Transceiver Hubs. In addition, the HubSat8 provides power to these cameras locally to eliminate the possibility of voltage drop associated with long cable runs.

Specifications:

Input:

- 115VAC 50/60Hz, 1.8 amp.
- Primary in-line fuses are rated @ 3.5A/250V.

Video:

- Eight (8) channels of quality video over twisted pair up to a distance of 750 ft. per channel.
- Eight (8) 75 ohm video outputs.

Data:

- RS422/RS485 data input.

Power:

- Individually selectable 24VAC or 28VAC power outputs with OFF position.
- Unit provides up to 1 amp max. per channel not to exceed a total of 8 amp maximum current.

Additional Models:

HubSat82

- HubSat8 w/eight (8) HubWayAv Video Balun/Combiners for 24VAC Cameras.

Power (cont.):

- Automotive blade fuses.
- Blade fuses are rated @ 3 amp per channel.
- Surge suppression.

Visual Indicators:

- Eight (8) power LED indicators.

Enclosure Dimensions:

13.5”H x 13”W x 3.25”D

Optional Accessories:

- Video Balun/Combiners:
 - HubWayAv - for use with 24VAC cameras.
 - HubWayDv - for use with 12VDC cameras.

HubSat83

- HubSat8 w/eight (8) HubWayDv Video Balun/Combiners for 12VDC Cameras.

Installation Instructions:

HubSat8 Passive UTP Transceiver Hub with Integral Camera Power.

1. Mount unit in desired location. Mark and predrill holes in the wall to line up with the top two keyholes in the enclosure. Install two upper fasteners and screws in the wall with the screw heads protruding. Place the enclosure's upper keyholes over the two upper screws, level and secure. Mark the position of the lower two holes. Remove the enclosure. Drill the lower holes and install the two fasteners. Place the enclosure's upper keyholes over the two upper screws. Install the two lower screws and make sure to tighten all screws (*Enclosure Dimensions, pg. 8*). Secure green wire lead to earth ground.
2. Set illuminated master power disconnect circuit breaker to the (OFF) position (*Fig. 4a, pg. 6*).
3. Connect 115VAC 50/60Hz to the black and white flying leads of open frame transformer. Secure ground wire (Green) to earth ground (*Fig. 5, pg. 7*). The power LEDs (Green) for Channels 1-8 of the HubSat8 will illuminate when AC power is present (*Fig. 1e, pg. 4*).
4. Select 24VAC or 28VAC power output for Channels 1-4 with the corresponding voltage adjustment switches (*Fig. 1d, pg. 4*).
5. Connect the BNC video outputs for HubSat8 Channels 1-8 to the corresponding video inputs on the head end equipment (DVR) (*Fig. 1a, pg. 4*).
6. Connect the RS422/RS485 output of the head end equipment (DVR) to the data terminals marked [+ Data -] of the HubSat8 unit (polarity must be observed) (*Fig. 1f, pg. 4*).

Note: The Data input terminals of the HubSat8 must be wired in parallel for proper operation. When using fixed cameras disregard this step.

7. Connect Video Balun/Combiner at camera 1 to the HubSat8 unit utilizing CAT-5 or higher structured cable. Plug the RJ45 connector at one end of a structured cable into the RJ45 jack marked [PVD1] of the HubSat8 (*Fig. 1i, pg. 4*). Plug the RJ45 connector at the opposite end of the structured cable into the RJ45 jack of the Video Balun/Combiner located at camera 1.

- For 24VAC cameras use Altronix model HubWayAv Video Balun/Combiner (Figs. 2a, 2b, pg. 6).
 - For 12VDC cameras use Altronix model HubWayDv Video Balun/Combiner (Figs. 2c, 2d, pg. 6).
- AC LED (Green) of the HubWayAv or DC LED (Red) of the HubWayDv Video Balun/Combiners will illuminate indicating power is present at the cameras (Fig. 2b, 2d, pg. 6).

The total cable distance must not exceed 750 ft. for video transmission between the HubSat8 and each camera.

Repeat this step for each additional camera [PVD2-8].

8. Set illuminated master power disconnect circuit breaker to the RESET (ON) position (Fig. 4a, pg. 6) and measure the output voltage at the power output of each Video Balun/Combiner (Figs. 2b, 2d, pg. 6) before powering each camera to insure proper operation and avoid possible damage.
 - HubWayAv - Terminals marked [AC POWER] (Figs. 2a, 2b, pg. 6).
 - HubWayDv - Terminals marked [- 12VDC +] (Figs. 2c, 2d, pg. 6).
9. Set illuminated master power disconnect circuit breaker to the (OFF) position (Fig. 4a, pg. 6).
10. Connect the power outputs of the HubWayAv or HubWayDv Video Balun/Combiners to the power inputs of the cameras (Figs. 2a-2d, pg. 6). Polarity must be observed.
11. Connect the terminals marked [+ DATA -] of the HubWayAv or HubWayDv Video Balun/Combiners to the data terminals of the cameras for PTZ control (Figs. 2b-2d, pg. 6). Polarity must be observed. When using fixed cameras disregard this step.
12. Connect the BNC connector of the HubWayAv or HubWayDv Video Balun/Combiners to the BNC video outputs of the cameras (Figs. 2b-2d, pg. 6).
13. Set illuminated master power disconnect circuit breaker to the RESET (ON) position (Fig. 4a, pg. 6).
14. The power LEDs (Green) or Channels 1-8 of the HubSat8 will illuminate when AC power is present (Fig. 1e, pg. 4). If any of these LEDs are off, a loss of AC power output may be due to a blown fuse caused by a short circuit or overload condition. If all of the LEDs are OFF there may be a complete loss of supply power to the HubSat8 unit or the illuminated master power disconnect circuit breaker is in the OFF position or the primary in-line fuse is blown.

To restore the power output for HubSat8:

- 1- Switch corresponding output voltage switch to the OFF position (Fig. 1d, pg. 4).
- 2- Eliminate the trouble condition.
- 3- Replace the corresponding automotive blade fuse.

Replace fuses with same type and rating:

Output fuses are rated @ 3 amp for all models.

Primary in-line fuses are rated @ 3.5A/250V (Fig. 4b, pg. 6).

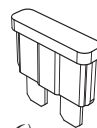

Automotive Blade Fuse

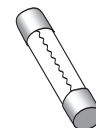

Primary In-line Fuse

- 4- Switch output voltage switch to the 24VAC or 28VAC position as desired (Fig. 1d, pg. 4).

HubSat8 for use as a Remote Accessory Module with HubWay/HubWayLD/HubWayLDH UTP Transceiver Hubs.

1. Mount unit in desired location. Mark and predrill holes in the wall to line up with the top two keyholes in the enclosure. Install two upper fasteners and screws in the wall with the screw heads protruding. Place the enclosure's upper keyholes over the two upper screws, level and secure. Mark the position of the lower two holes. Remove the enclosure. Drill the lower holes and install the two fasteners. Place the enclosure's upper keyholes over the two upper screws. Install the two lower screws and make sure to tighten all screws (Enclosure Dimensions, pg. 8). Secure green wire lead to earth ground.
2. Set illuminated master power disconnect circuit breaker to the (OFF) position (Fig. 4a, pg. 6).
3. Connect 115VAC 50/60Hz to the black and white flying leads of open frame transformer. Secure ground wire (Green) to earth ground (Fig. 6, pg. 7). The power LEDs (Green) for Channels 1-8 of the HubSat8 will illuminate when AC power is present (Fig. 1e, pg. 4).
4. Select 24VAC or 28VAC power output for Channels 1-8 with the corresponding voltage adjustment switches (Fig. 1d, pg. 4).
5. Video connection between HubSat8 and HubWay/HubWayLD/HubWayLDH:
 Plug the RJ45 connector at one end of a structured cable into the RJ45 jack marked [Video 1-8] of the HubSat8 (Fig. 1g, pg. 4).
 Plug the RJ45 connector at the opposite end of the structured cable into the RJ45 jack marked [Channels 1-4, Channels 5-8, Channels 9-12, Channels 13-16] of the HubWay/HubWayLD/HubWayLDH (Fig. 6, pg. 7).
6. Data connection between HubSat8 and HubWay/HubWayLD/HubWayLDH UTP Transceiver Hubs:
 Plug the RJ45 connector at one end of a structured cable into the RJ45 jack marked [Data 1-4] of the HubSat8 (Fig. 1h, pg. 4).

Plug the RJ45 connector at the opposite end of the structured cable into the corresponding RJ45 channel jack of the HubWay/HubWayLD/HubWayLDH UTP Transceiver Hubs (Fig. 6, pg. 7).

When using fixed cameras disregard this step.

Example: Using RJ45 jack marked [Video 1-4] of HubSat8 connected to [Channels 1-4] of the HubWay/HubWayLD/HubWayLDH for video transmission, Using the RJ45 jack marked [Data 1-4] of HubSat8 connected to the Channel jack marked [4] of the HubWay/HubWayLD/HubWayLDH.

Note: Channels 1-3 can not be used for video transmission when using the RJ45 jack marked [CH 1-4] of the HubWay/HubWayLD/HubWayLDH.

The output voltage switches 1-8 must be set to OFF position (Fig. 6, pg. 7).

7. Connect Video Balun/Combiner at camera 1 to the HubSat8 unit utilizing CAT-5 or higher structured cable. Plug the RJ45 connector at one end of a structured cable into the RJ45 jack marked [PVD1] of the HubSat8 (Fig. 1e, pg. 4). Plug the RJ45 connector at the opposite end of the structured cable into the RJ45 jack of the Video Balun/Combiner located at camera 1.
 - For 24VAC cameras use Altronix model HubWayAv Video Balun/Combiner (Figs. 2a, 2b, pg. 6).
 - For 12VDC cameras use Altronix model HubWayDv Video Balun/Combiner (Figs. 2c, 2d, pg. 6).
 AC LED (Green) of the HubWayAv or DC LED (Red) of the HubWayDv Video Balun/Combiners will illuminate indicating power is present at the cameras (Fig. 2b, 2d, pg. 6). Repeat this step for each additional camera [OUT2-4].

Note: The combined total cable distance for video transmission must not exceed the following distances:

 - 750 ft. between the HubWay and each camera routed through the HubSat8.
 - 3000 ft. between the HubWayLD/HubWayLDH and each camera routed through the HubSat8.
8. Set illuminated master power disconnect circuit breaker to the RESET (ON) position (Fig. 4, pg. 6) and measure the output voltage at the power output of each Video Balun/Combiner (Figs. 2b, 2d, pg. 6) before powering each camera to insure proper operation and avoid possible damage.
 - HubWayAv - Terminals marked [AC POWER] (Figs. 2a, 2b, pg. 6).
 - HubWayDv - Terminals marked [- 12VDC +] (Figs. 2c, 2d, pg. 6).

Fig. 1 - HubSat8 Circuit Board

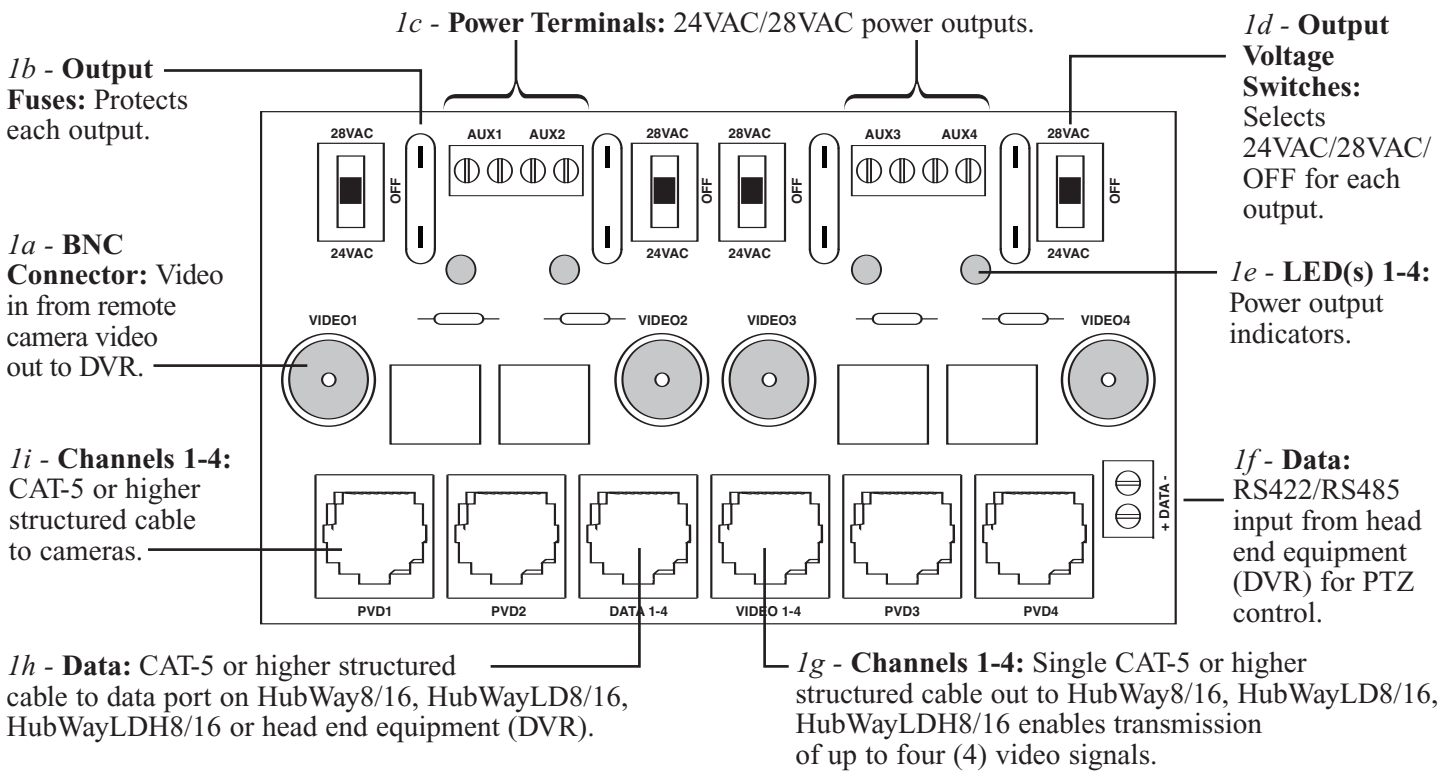

9. Set illuminated master power disconnect circuit breaker to the (OFF) position (*Fig. 4a, pg. 6*).
10. Connect the power outputs of the HubWayAv or HubWayDv Video Balun/Combiners to the power inputs of the cameras (*Figs. 2a-2d, pg. 5*). Polarity must be observed.
11. Connect the terminals marked [+ DATA -] of the HubWayAv or HubWayDv Video Balun/Combiners to the data terminals of the cameras for PTZ control (*Figs. 2a-2d, pg. 5*). Polarity must be observed.
When using fixed cameras disregard this step.
12. Connect the BNC connector of the HubWayAv or HubWayDv Video Balun/Combiners to the BNC video outputs of the cameras (*Figs. 2b-2d, pg. 6*).
13. Set illuminated master power disconnect circuit breaker to the RESET (ON) position (*Fig. 4a, pg. 6*).
14. The power LEDs (Green) or Channels 1-8 of the HubSat8 will illuminate when AC power is present (*Fig. 1e, pg. 4*). If any of these LEDs are off, a loss of AC power output may be due to a blown fuse caused by a short circuit or overload condition. If all of the LEDs are OFF there may be a complete loss of supply power to the HubSat8 unit or the illuminated master power disconnect circuit breaker is in the OFF position or the primary in-line fuse is blown.

To restore the power output for HubSat8:

- 1- Switch corresponding output voltage switch to the OFF position (*Fig. 1d, pg. 4*).
- 2- Eliminate the trouble condition.
- 3- Replace the corresponding automotive blade fuse.

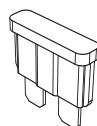

Automotive Blade Fuse

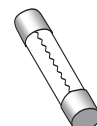

Primary In-line Fuse

Replace fuses with same type and rating:

Output fuses are rated @ 3 amp for all models.

Primary in-line fuses are rated @ 3.5A/250V (*Fig. 4b, pg. 6*).

- 4- Switch output voltage switch to the 24VAC or 28VAC position as desired (*Fig. 1d, pg. 4*).

Alternate 24VAC fixed camera hookup (*Fig. 6a, pg. 7*).

After completing steps 1-5 from Installation Instructions Remote Accessory Module for use with HubWay/HubWayLD/HubWayLDH UTP Transceiver Hubs proceed with the following.

1. Set illuminated master power disconnect circuit breaker to the (OFF) position (*Fig. 4a, pg. 6*).
2. Connect one end of the coaxial cable to the BNC connector marked [Video1] of the HubSat8/4D (*Fig. 1a, pg. 4*). Connect the opposite end of the coaxial cable to the BNC video output of camera 1 (*Fig. 6a, pg. 7*).
3. Set illuminated master power disconnect circuit breaker to the RESET (ON) position (*Fig. 4a, pg. 6*) measure the output voltage at terminal pair marked [AUX1] of the HubSat8 to insure proper operation and avoid possible damage (*Fig. 1b, pg. 4*).
4. Connect the power output terminal pair marked [AUX1] to the power inputs of camera 1 (*Fig. 1c, pg. 4*). Repeat steps 1-3 for each additional camera (Channels 2-4).

HubWay Video Balun/Combiner Reference Chart:

Altronix Model Number	Output Voltage to camera	Input Voltage from HubSat	Camera Type	Power LED
HubWayAv	*24VAC/28VAC	*24VAC/28VAC	Use with AC cameras	Green
HubWayDv	12VDC	*24VAC/28VAC	Use with DC cameras	Red

*Based on camera load and structured cable length.

Fig. 2 - HubWayAv and HubWayDv Video Balun/Combiners

Fig. 2a

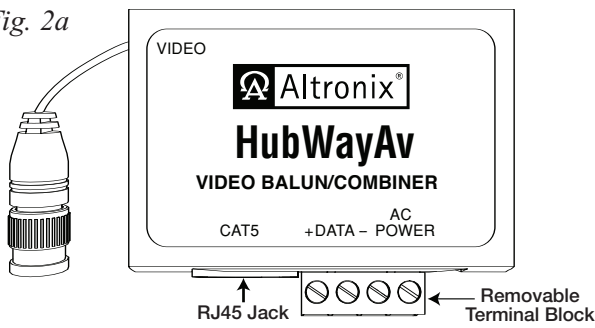

Fig. 2c

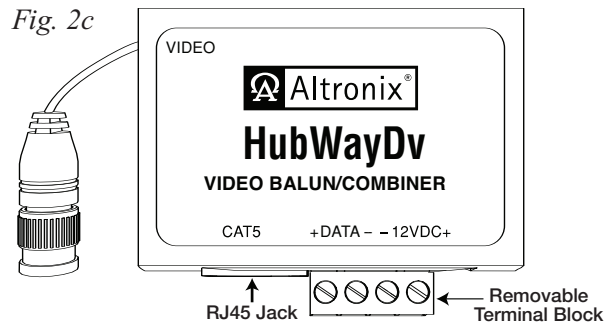

Fig. 2b

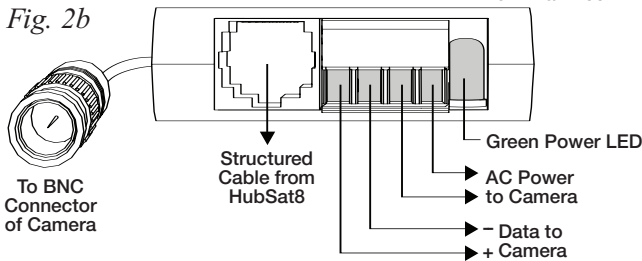
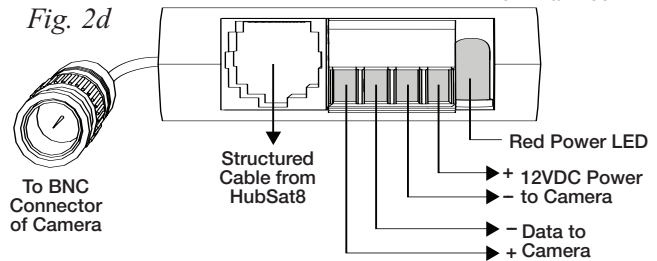

Fig. 2d



HubWayAv passes AC voltage through pins 4, 5, 7, 8 and [AC Power] terminals.

HubWayDv converts AC voltage to DC voltage through pins 4, 5, 7, 8 and [- 12VDC +] terminals.

Fig. 3 - CAT5 Wiring Color Codes

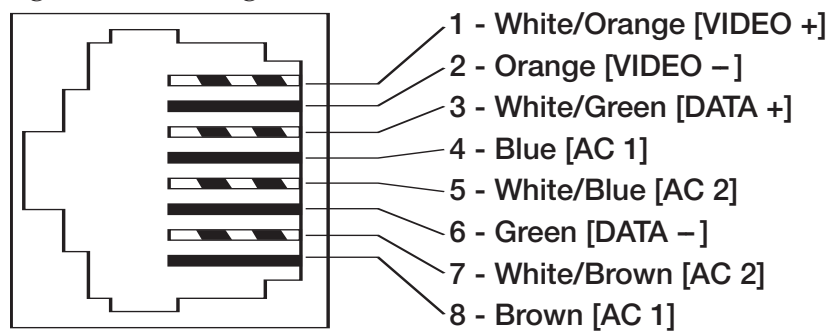

Fig. 4

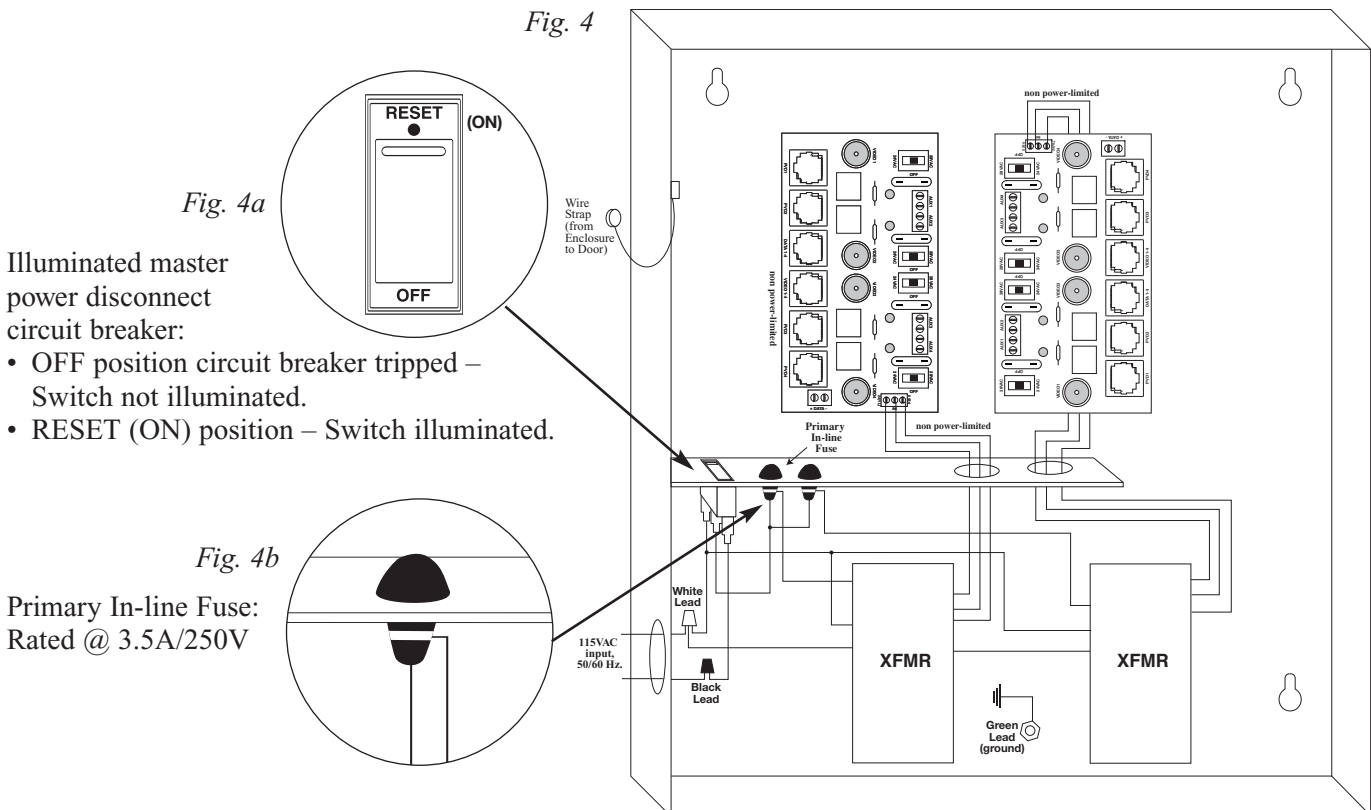

Fig. 4a

Illuminated master power disconnect circuit breaker:

- OFF position circuit breaker tripped – Switch not illuminated.
- RESET (ON) position – Switch illuminated.

Fig. 4b

Primary In-line Fuse:
Rated @ 3.5A/250V

Typical Application Drawing for HubSat8 as a Passive UTP Transceiver Hub with Integral Camera Power:

Fig. 5 Head End Equipment (DVR)

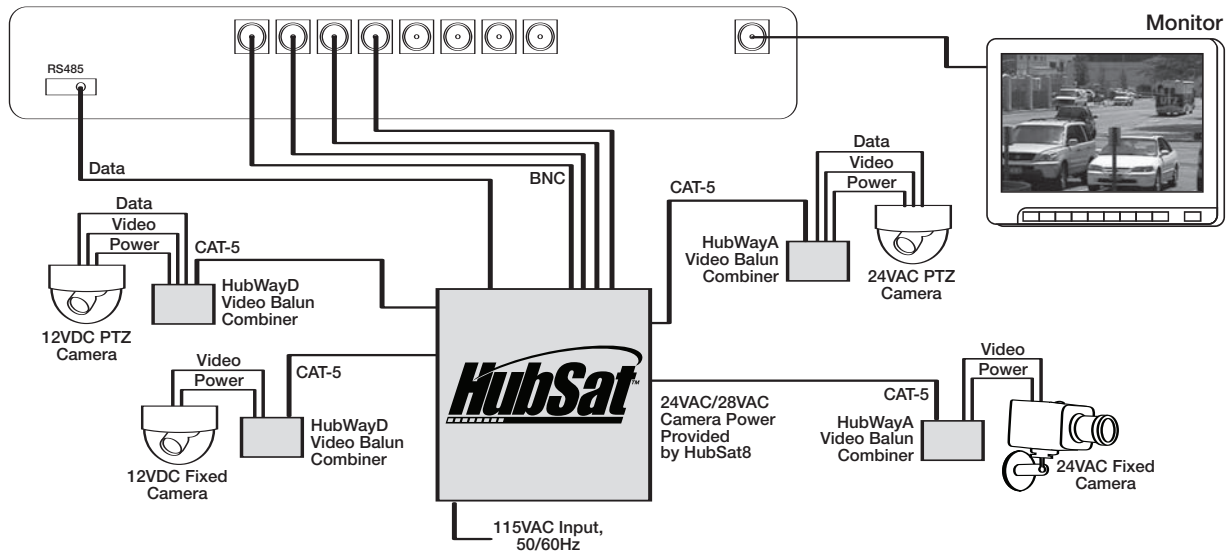

Typical Application Drawing for HubSat8 as a Remote Accessory Module for use with HubWay/HubWayLD/HubWayLDH UTP Transceiver Hubs:

Fig. 6

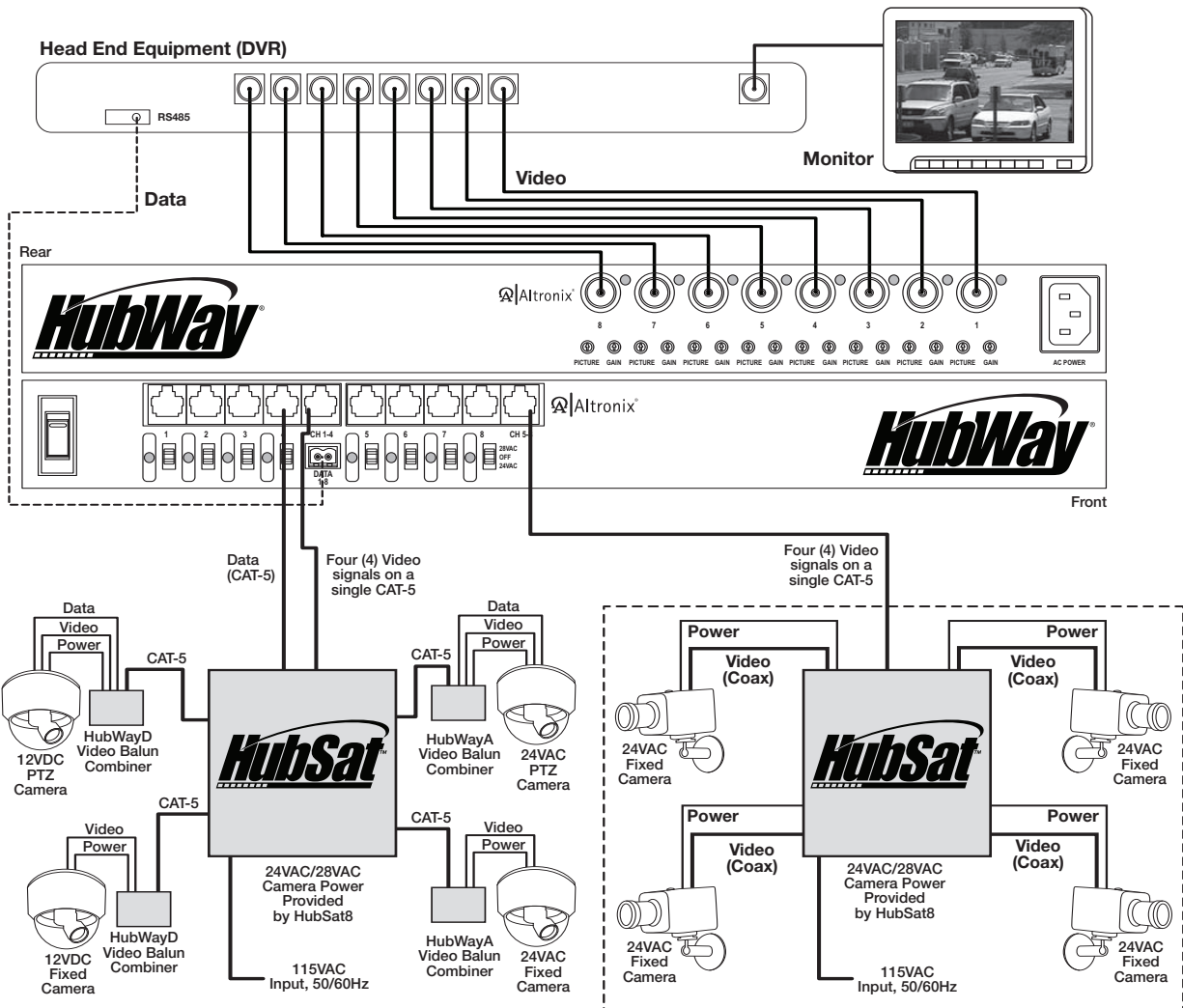

Fig. 6a - Alternate 24VAC fixed camera hookup.



The lightning flash with arrow head symbol within an equilateral triangle is intended to alert the user to the presence of an insulated "DANGEROUS VOLTAGE" within the products enclosure that may be of sufficient magnitude to constitute an electric shock.



The exclamation point within an equilateral triangle is intended to alert the user to the presence of important operating and maintenance (servicing) instructions in the literature accompanying the appliance.



CAUTION
RISK OF ELECTRIC SHOCK
DO NOT OPEN



CAUTION: To reduce the risk of electric shock do not open enclosure. There are no user serviceable parts inside. Refer servicing to qualified service personnel.

Enclosure Dimensions:

13.5"H x 13"W x 3.25"D

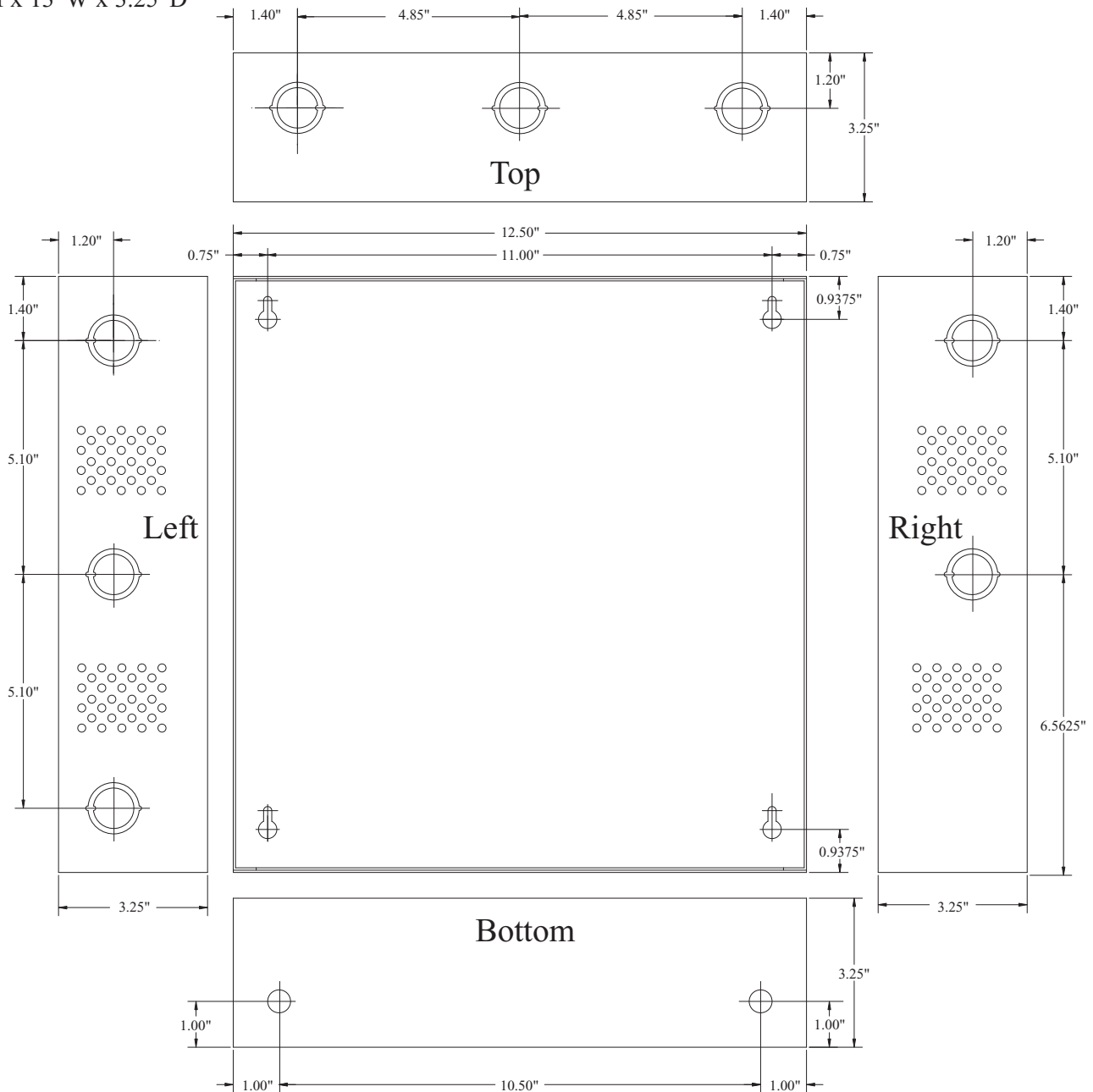

Altronix is not responsible for any typographical errors.

140 58th Street, Brooklyn, New York 11220 USA, 718-567-8181, fax: 718-567-9056
 website: www.altronix.com, e-mail: info@altronix.com, Lifetime Warranty, Made in U.S.A.
 IIHubSat8 F11H

